

CLINCHER™

Connector System for Flexible Circuitry (0.100in./2.54mm pitch)
Maximum reliability; Low applied cost

DESCRIPTION

The CLINCHER™ connector family includes single-row pin and receptacle connectors designed for termination to flat flexible circuitry. Products are available for Flat Flexible Cable (FFC), Flexible Printed Circuit (FPC), and Conductive Ink Circuitry (CIC).

The connectors include features that optimize reliability at both the termination and disconnect interfaces. “Clinch” cable termination produces gas-tight, contamination-free connections to each conductor. The receptacle connectors utilize FCI’s proven and highly-reliable Mini PV™ contact design. Complementary shrouded PCB headers provide options for latching and proper connector alignment.

Contacts are pre-loaded to connector housings enabling mass termination to unprepared cable. The CLINCHER™ connector mass termination design accelerates cable assembly processes and reduces costs.

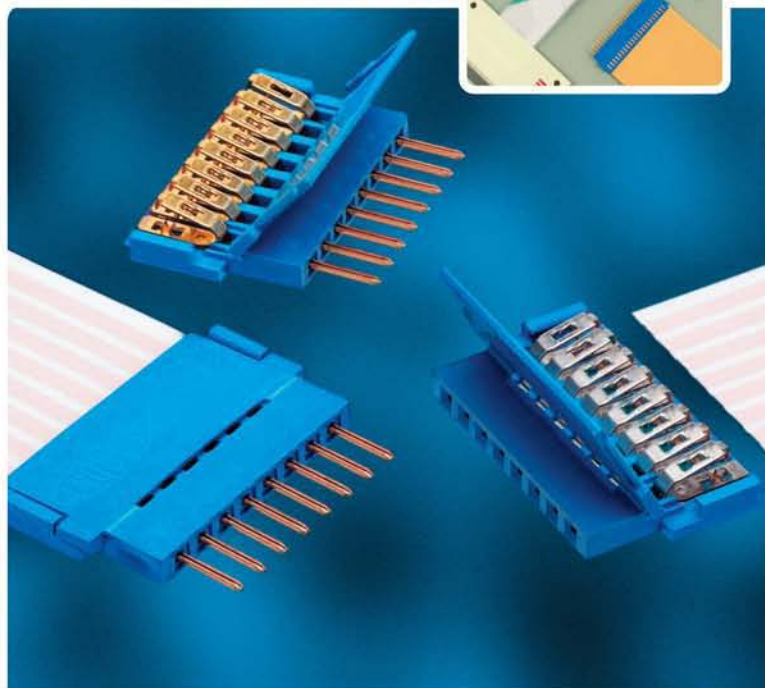

FEATURES & BENEFITS

- “Clinch” cable termination provides four gas-tight, contamination-free contact points to each conductor
- Receptacle design features highly-reliable Mini PV dual-metal contacts
- Mass termination to unprepared cable reduces assembly costs
- Housing window permits crimp inspection to verify proper termination
- Receptacle openings feature a beveled “lead-in” to reduce risk of stubbing with mating pins
- Connector sizes range from 2 to 34 positions
- Polarization options aid proper alignment and mating
- Positive-locking, latching options assure secure mating to industry-standard headers for severe applications
- Economy two-wall PCB headers provide passive latching and polarization at a reduced cost
- Lead-free, RoHS compliant products satisfy environmental regulations

TARGET MARKETS / APPLICATIONS

- Appliances and White goods
- Membrane Switches and Electronic Displays
- Industrial and Instrumentation
- Medical
- POS equipment
- Hand-held terminals

CLINCHER™ RECEPTACLES

RECEPTACLE STANDARD SERIES 65801

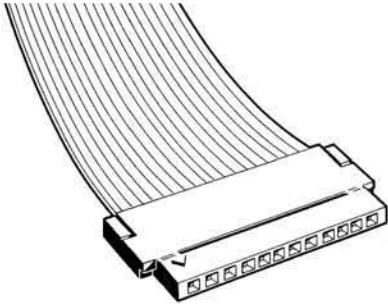

- Positions available: 2 through 32
- Plating Options: Gold/GXT or lead-free pure tin
- Mates best with: Clincher Pin Connectors Series 66226 or FCI Mini-latch pin connectors or BergStik™ / equivalent .025in. sq. posted. 0.100in. pitch un-shrouded headers

RECEPTACLE OUTSIDE BAR POLARIZED WITH PASSIVE LATCHING SERIES 67516

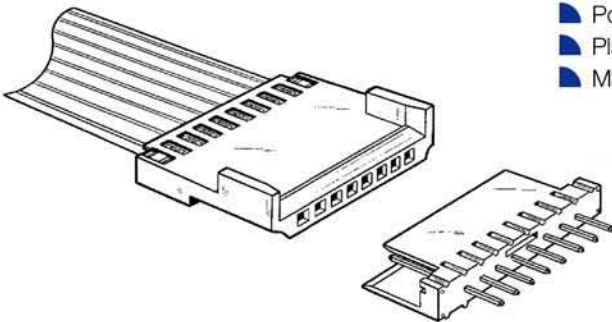

- Positions available: 2 through 16
- Plating Options: Gold/GXT or lead-free pure tin
- Mates best with: Clincher PCB Pin Headers Series 95735, 95736

RECEPTACLE INSIDE BAR POLARIZED SERIES 10027313

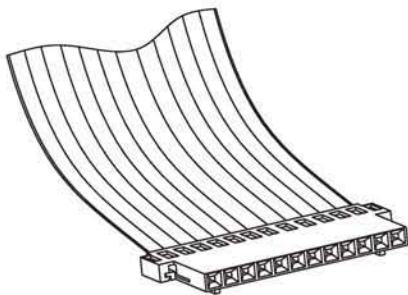

- Positions available: 6 through 34
- Plating Options: Gold/GXT or lead-free pure tin
- Mates best with industry standard PCB Pin connectors or BergStik™ / equivalent .025in. sq. posted, 0.100in. pitch un-shrouded headers

RECEPTACLE INSIDE BAR POLARIZED WITH LATCHING SERIES 10022753

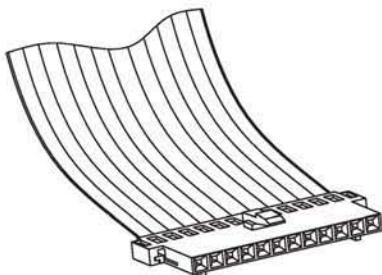

- Positions available: 6 through 34
- Plating Options: Gold/GXT or lead-free pure tin
- Mates best with industry standard PCB Pin connectors

CLINCHER™ PIN CONNECTORS

PIN CONNECTOR, CABLE TERMINATION SERIES 66226

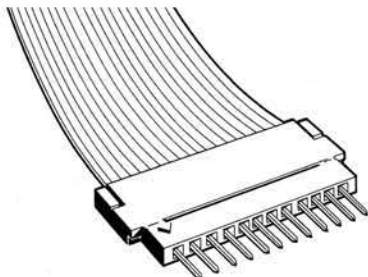

- ▀ Positions available: 3 through 14
- ▀ Plating Options: Gold/GXT or lead-free pure tin
- ▀ Mates best with: Clincher™ Receptacle, Standard Series 65801; FCI Mini-latch/Mini-PV™ Connectors

PIN CONNECTOR PCB VERTICAL MOUNT OUTSIDE-BAR POLARIZED WITH PASSIVE LATCHING SERIES 95735

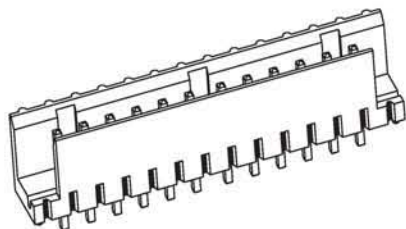

- ▀ Positions available: 2 through 16
- ▀ Plating Options: Gold/GXT or lead-free pure tin
- ▀ Mates best with Clincher™ Receptacle, Outside-bar polarized with Passive Latching Series 67516

PIN CONNECTOR PCB RIGHT ANGLE MOUNT OUTSIDE-BAR POLARIZED WITH PASSIVE LATCHING SERIES 95736

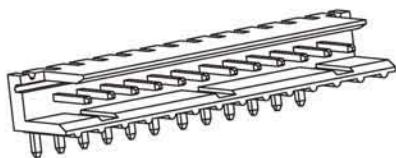

- ▀ Positions available: 2 through 16
- ▀ Plating Options: Gold/GXT or lead-free pure tin
- ▀ Mates best with Clincher™ Receptacle, Outside-bar polarized with Passive Latching Series 67516

MATERIALS

- Housings: Polypropylene UL 94 V-O, Blue
- Contact body base metal: Receptacles: Cupro-nickel; Pin Headers: Phosphor Bronze
- Contact spring base metal: Beryllium Copper
- Plating, contact spring: 3u Gold/GXT or 10u lead-free pure tin; All over 50u Nickel
- Plating, contact body: 30u Gold/GXT or 100u lead-free pure tin; All over 50u Nickel

ELECTRICAL PERFORMANCE

- Contact resistance (LLCR) main contacts: 10 mΩ max; 20 mΩ max after environmental exposure
- Insulation Resistance: 5000 MΩ min
- Withstanding voltage: 1000 VAC RMS
- Current Rating: 2.0 amp continuous per contact

CABLE SPECIFICATION

- Specification: IPC Standard, FC-220 B Cables type A or B, tolerance class IV
- Cable thickness: 0.33mm (0.013in.) max including insulation.
- Insulation material: *Mylar*® or KAPTON® Polyimide.
- Conductor thickness: 0.076 +/- 0.013mm (0.003 +/- 0.0005 in) 305 gr/m²
- Conductor width: 1.57 +/- 0.07mm (0.062 +/- 0.0003 in)

MECHANICAL PERFORMANCE

- Mating and Un-mating force: 300 grams max per contact (does not include latching force)
- Latch retention: 4 lbs minimum
- Contact retention: 30 grams min per contact
- Cable retention: 10 lbs per inch of cable width.
- Contact durability: 100 mating cycles

PACKAGING

- Anti-static Trays

SPECIFICATIONS

- Product Specification: BUS-12-021, BUS-12-022

APPLICATION DATA

- TA-372, TA-264, TA-371

APPLICATION TOOLING

PV-219E Semi-Automatic Application Machine

- For mass-terminating both pin and receptacle Clincher connectors to flat flexible circuitry or flat conductor flat cable
- Bench model
- Pneumatically operated
- Tooling is adjustable for single-row housing sizes
- Quick changeover for different housing sizes
- Microprocessor controlled
- Machine PN 166652-001



HT-0274 Hand Tool

- For terminating certain pin or receptacle Clincher connectors to flat flexible circuitry or flat conductor cable
- Terminates at all positions
- Terminates 67516 series only
- Lightweight and rugged
- Ratchet handle assures complete crimp cycle
- Simple to operate
- Tool PN HT-0274

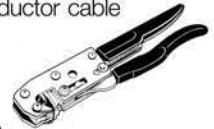

HT 270 Hand Tool

- For terminating certain pin or receptacle Clincher connectors to flat flexible circuitry or flat conductor cable
- Terminates 2, 3, or 4 positions at one time
- Ratchet handle assures complete crimp cycle
- Lightweight and rugged
- Simple to operate
- Terminates 65801 series and 66226 series only
- Tool PN HT 270



Mylar® is a DuPont Teijin Films registered trademark for its Polyester Film. Only DuPont Teijin Films makes *Mylar*®.

KAPTON® is a registered trademark of DuPont